

Wiring Diagram For 24VDC Digital Output Module With NPN OUTPUT (Negative Logic)

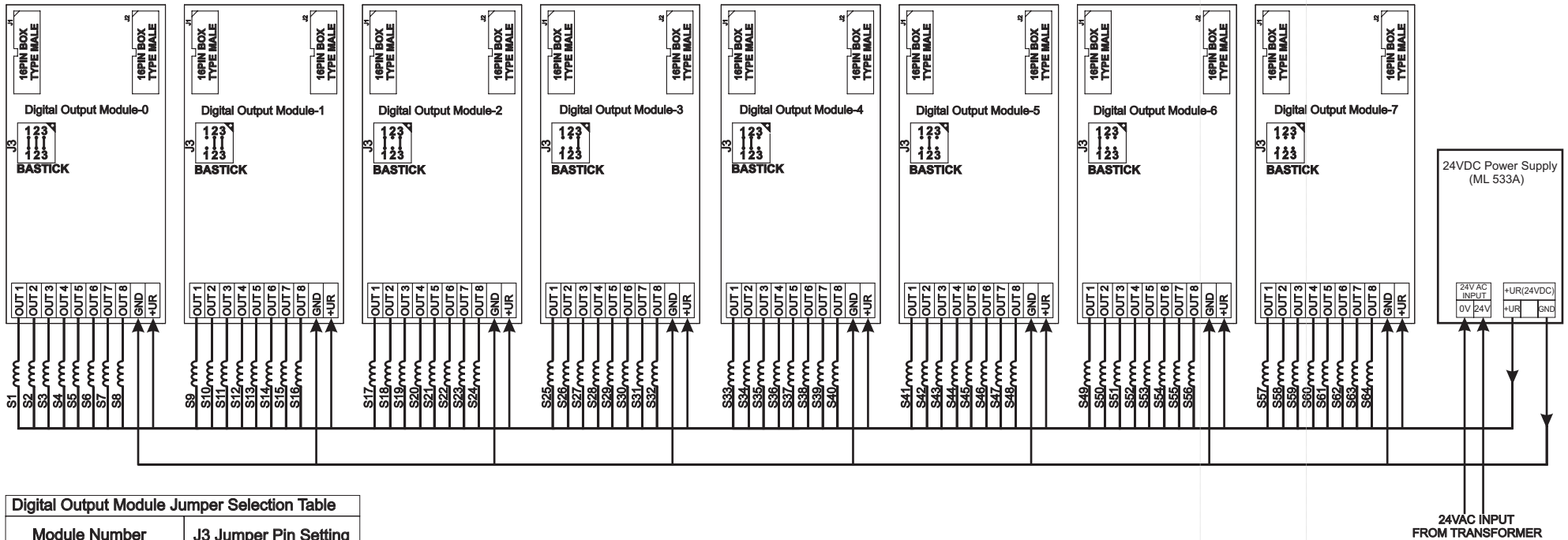

Digital Output Module Jumper Selection Table	
Module Number	J3 Jumper Pin Setting
Digital Output Module-0	
Digital Output Module-1	
Digital Output Module-2	
Digital Output Module-3	
Digital Output Module-4	
Digital Output Module-5	
Digital Output Module-6	
Digital Output Module-7	

Note: All Digital output modules are the same.

J3 position decides digital output module number.

For ex. for **J3=0** (Module No: 0), the corresponding outputs will be from S1 to S8.

for **J3=1** (Module No: 1), the corresponding outputs will be from S9 to S16 and so on.

For description of S1.. To SX, Please refer INPUT/OUTPUT list in the operating manual.

All digital output modules are same and can be identified by the jumper setting of **J3**.

Wiring Diagram For Digital Input Module With NPN Type (Negative Logic)

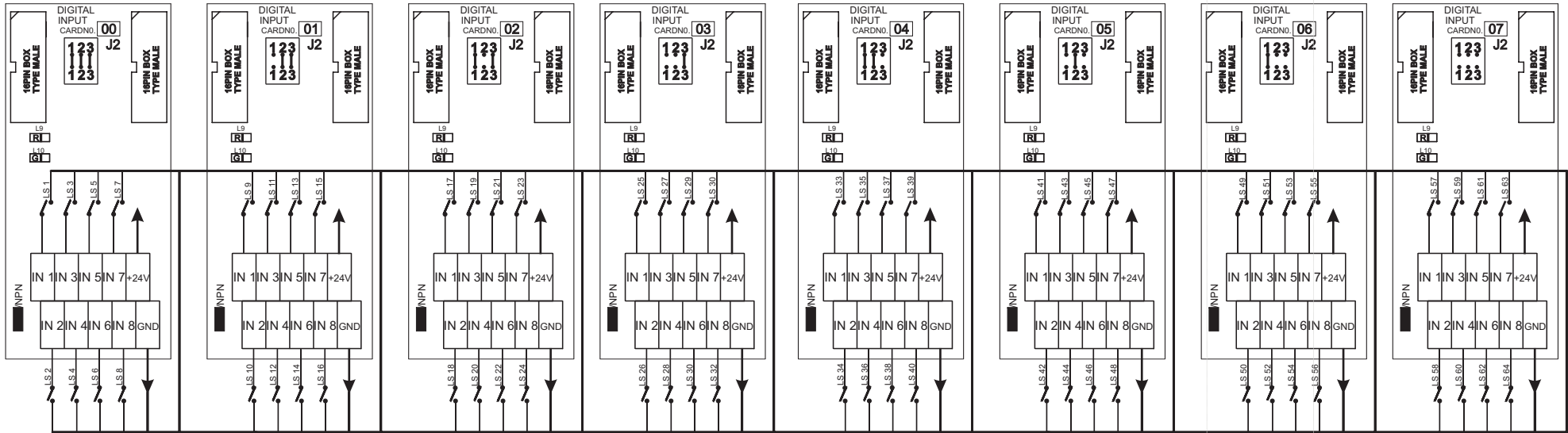

Module Number	J2 Jumper Pin Setting
Digital Input Module-0	
Digital Input Module-1	
Digital Input Module-2	
Digital Input Module-3	
Digital Input Module-4	
Digital Input Module-5	
Digital Input Module-6	
Digital Input Module-7	

Note: All Digital input modules are the same.
J2 position decides digital input module number.
 For ex. for **J2=0** (Module No: 0), the corresponding inputs will be from **LS1** to **LS8**.
 for **J2=1** (Module No: 1), the corresponding inputs will be from **LS9** to **LS16** and so on.
 For description of LS1.. To LSX, Please refer INPUT/OUTPUT list in the operating manual.
 All digital input modules are same and can be identified by the jumper setting of **J2**.

Wiring Diagram For Digital Input Module With PNP Type (Positive Logic)

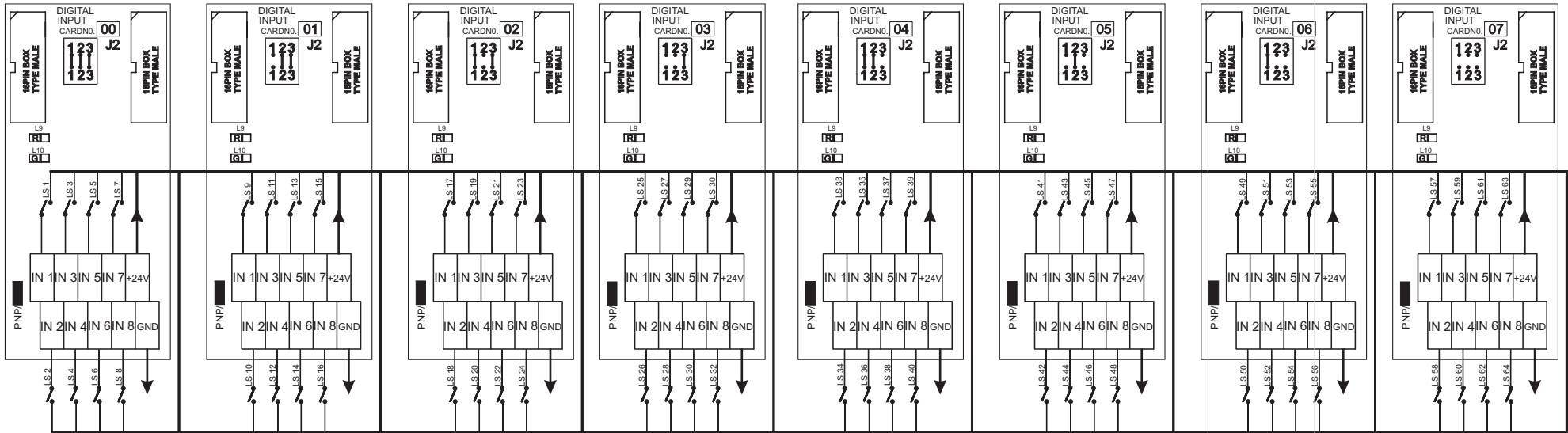

Digital Input Module Jumper Selection Table	
Module Number	J2 Jumper Pin Setting
Digital Input Module-0	
Digital Input Module-1	
Digital Input Module-2	
Digital Input Module-3	
Digital Input Module-4	
Digital Input Module-5	
Digital Input Module-6	
Digital Input Module-7	

Note: All Digital input modules are the same.
J2 position decides digital input module number.
 For ex. for **J2=0** (Module No: 0), the corresponding inputs will be from **LS1** to **LS8**.
 for **J2=1** (Module No: 1), the corresponding inputs will be from **LS9** to **LS16** and so on.
 For description of LS1.. To LSX, Please refer INPUT/OUTPUT list in the operating manual.
 All digital input modules are same and can be identified by the jumper setting of **J2**.

Wiring Diagram For Analog Output Module

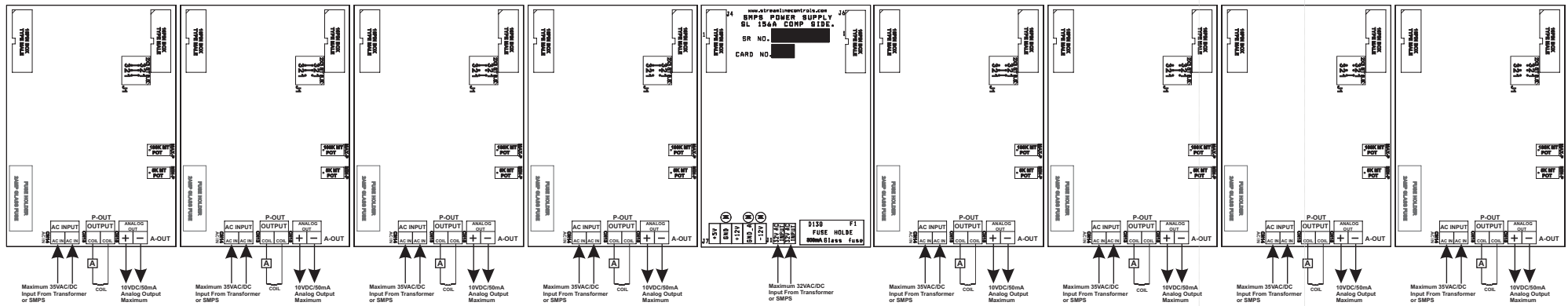

Analog Module Jumper Selection Table	
Module Number	J1 Jumper Pin Setting
Analog Output Module-0	
Analog Output Module-1	
Analog Output Module-2	
Analog Output Module-3	
Analog Output Module-4	
Analog Output Module-5	
Analog Output Module-6	
Analog Output Module-7	

Note: All Analog Output modules are the same.

J1 position decides ANALOG output module number.

For ex. for **J1=0** (Module No: 0), the corresponding output will be AN3 (Analog Output 3).

for **J1=1** (Module No: 1), the corresponding output will be AN4 (Analog Output 4).

For description of AN1.. To ANX, Please refer INPUT/OUTPUT list in the operating manual.

All Analog output modules are same and can be identified by the jumper setting of **J1**.

Wiring Diagram For 230VAC SSR Output Module

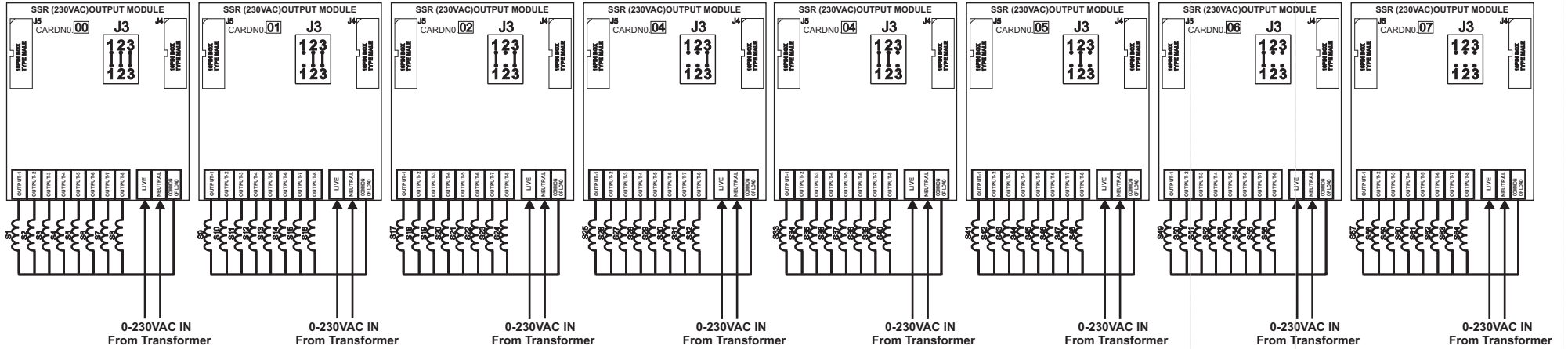

SSR Module Jumper Selection Tablel	
Module Number	J3 Jumper Pin Setting
SSR Output Module-0	
SSR Output Module-1	
SSR Output Module-2	
SSR Output Module-3	
SSR Output Module-4	
SSR Output Module-5	
SSR Output Module-6	
SSR Output Module-7	

Note: All SSR output modules are the same.
J3 position decides SSR output module number.
 For ex. for **J3=0** (Module No: 0), the corresponding outputs will be from S1 to S8.
 for **J3=1** (Module No: 1), the corresponding outputs will be from S9 to S16 and so on.
 For description of S1.. To SX, Please refer INPUT/OUTPUT list in the operating manual.
 All SSR output modules have same physical circuit layout are identified by the jumper setting of **J3**.

Wiring Diagram For Analog Input Module or Encoder Input Module

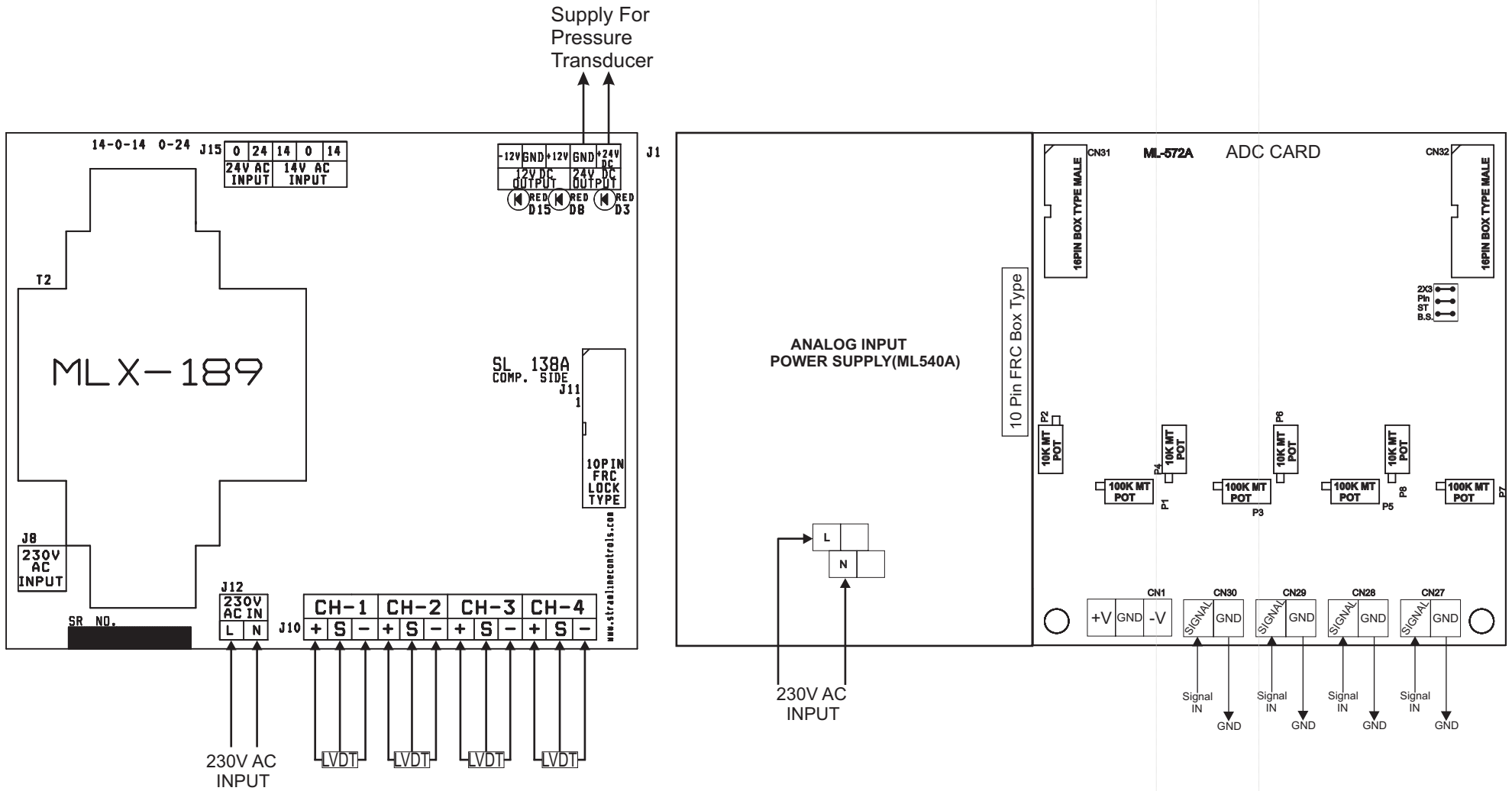

Wiring Diagram For Junction Card

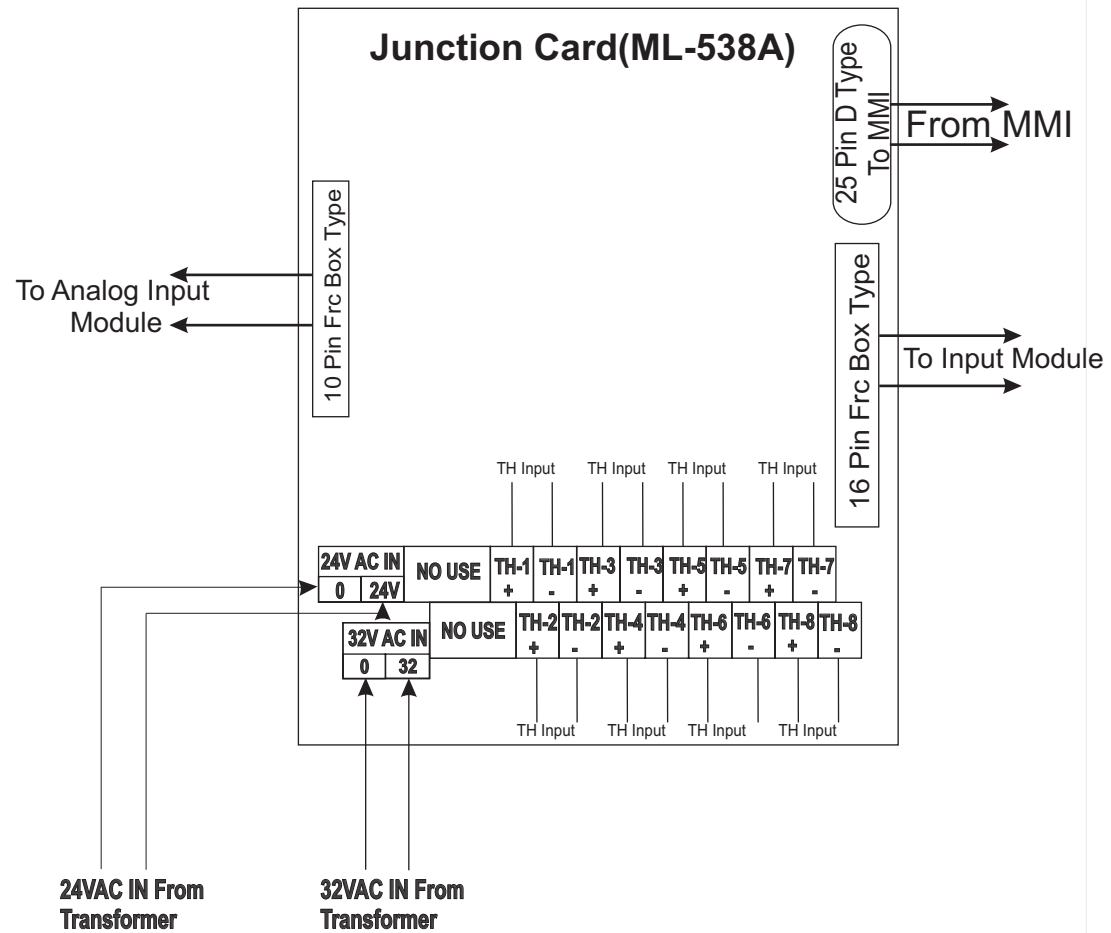

Wiring Diagram For Encoder Input Module

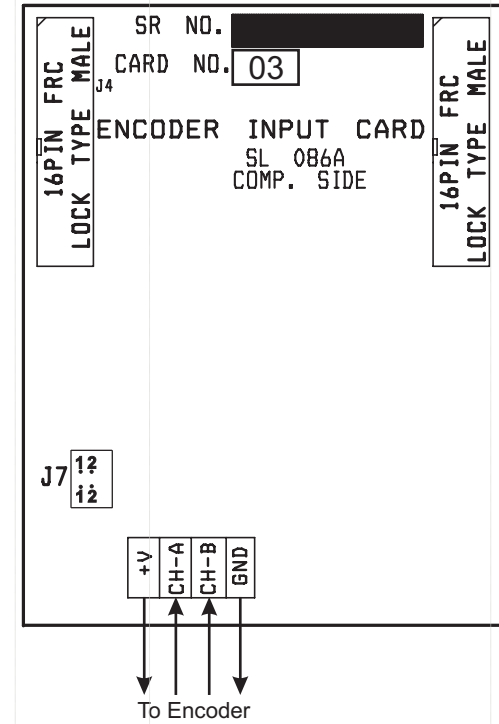
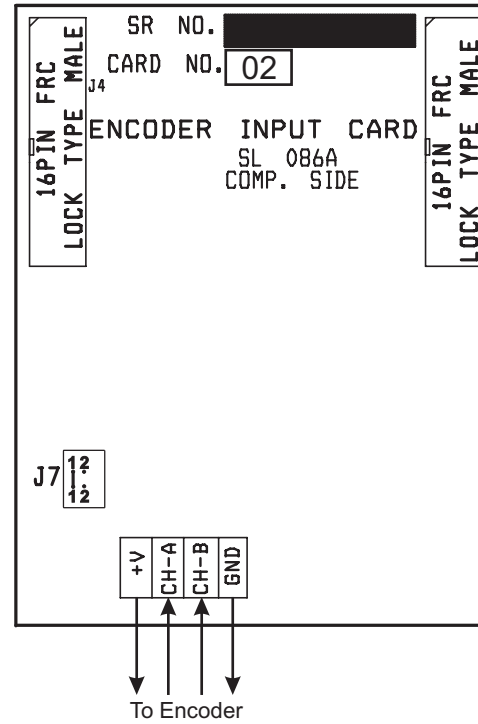
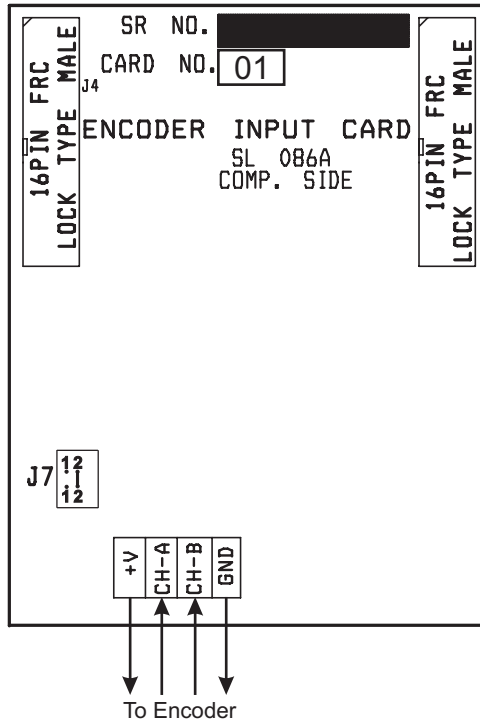
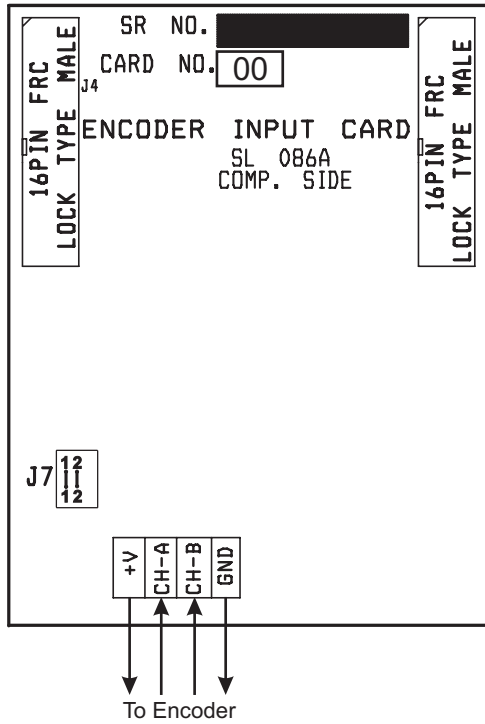

Encoder Input Module Jumper Selection Tabel																			
Module Number	J7 Jumper Pin Setting																		
Encoder Input Module-0	<table border="1" style="text-align: center;"> <tr><td>1</td><td>2</td><td>3</td></tr> <tr><td>•</td><td>•</td><td>•</td></tr> <tr><td>•</td><td>•</td><td>•</td></tr> <tr><td>1</td><td>2</td><td>3</td></tr> </table>	1	2	3	•	•	•	•	•	•	1	2	3						
1	2	3																	
•	•	•																	
•	•	•																	
1	2	3																	
Encoder Input Module-1	<table border="1" style="text-align: center;"> <tr><td>1</td><td>2</td><td>3</td></tr> <tr><td>•</td><td>•</td><td>•</td></tr> <tr><td>•</td><td>•</td><td>•</td></tr> <tr><td>1</td><td>2</td><td>3</td></tr> </table>	1	2	3	•	•	•	•	•	•	1	2	3						
1	2	3																	
•	•	•																	
•	•	•																	
1	2	3																	
Encoder Input Module-2	<table border="1" style="text-align: center;"> <tr><td>1</td><td>2</td><td>3</td></tr> <tr><td>•</td><td>•</td><td>•</td></tr> <tr><td>•</td><td>•</td><td>•</td></tr> <tr><td>•</td><td>•</td><td>•</td></tr> <tr><td>1</td><td>2</td><td>3</td></tr> </table>	1	2	3	•	•	•	•	•	•	•	•	•	1	2	3			
1	2	3																	
•	•	•																	
•	•	•																	
•	•	•																	
1	2	3																	
Encoder Input Module-3	<table border="1" style="text-align: center;"> <tr><td>1</td><td>2</td><td>3</td></tr> <tr><td>•</td><td>•</td><td>•</td></tr> <tr><td>•</td><td>•</td><td>•</td></tr> <tr><td>•</td><td>•</td><td>•</td></tr> <tr><td>•</td><td>•</td><td>•</td></tr> <tr><td>1</td><td>2</td><td>3</td></tr> </table>	1	2	3	•	•	•	•	•	•	•	•	•	•	•	•	1	2	3
1	2	3																	
•	•	•																	
•	•	•																	
•	•	•																	
•	•	•																	
1	2	3																	

Note: All Encoder input modules are the same.

J7 position decides Encoder input module number.

For ex. for **J1=0** (Module No: 0), the corresponding input will be EN1 (Encoder Input 1).

for **J1=1** (Module No: 1), the corresponding input will be EN1 (Encoder Input 2).

For description of EN1.. To ENX, Please refer INPUT/OUTPUT list in the operating manual.

All Encoder input modules are same and can be identified by the jumper setting of **J7**.

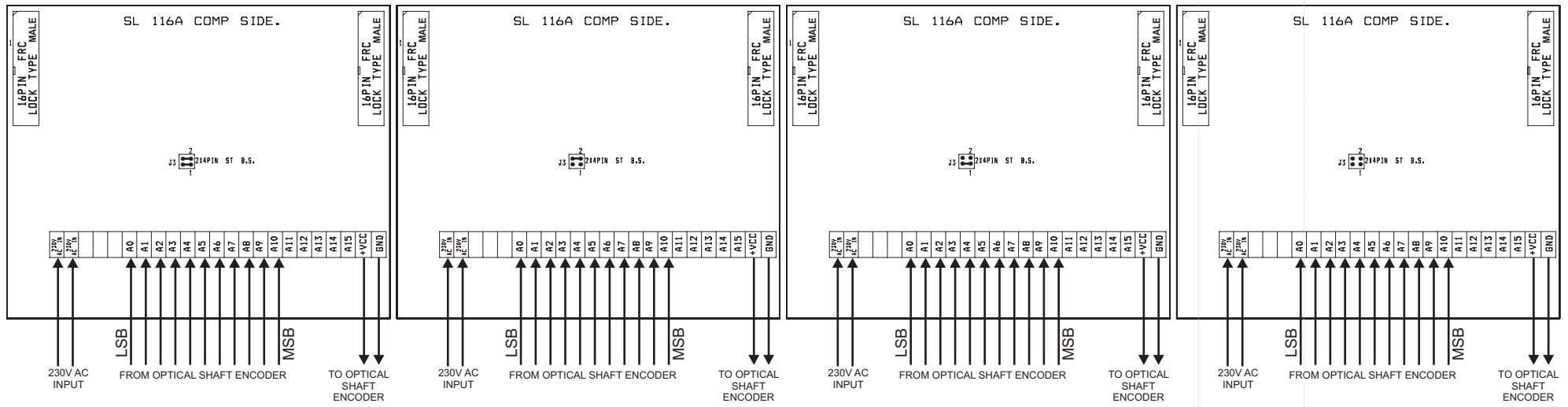

Absolute Encoder Input Module Jumper Selection Tabel	
Module Number	J3 Jumper Pin Setting
Absolute Encoder Input Module-0	
Absolute Encoder Input Module-1	
Absolute Encoder Input Module-2	
Absolute Encoder Input Module-3	

Note: All Absolute Encoder input modules are the same.
J3 position decides Encoder input module number.
 For ex. for **J3=0** (Module No: 0), the corresponding input will be EN1 (Encoder Input 1).
 for **J3=1** (Module No: 1), the corresponding input will be EN2 (Encoder Input 2).
 For description of EN1.. To ENX, Please refer INPUT/OUTPUT list in the operating manual.
 All Encoder input modules are same and can be identified by the jumper setting of **J3**.

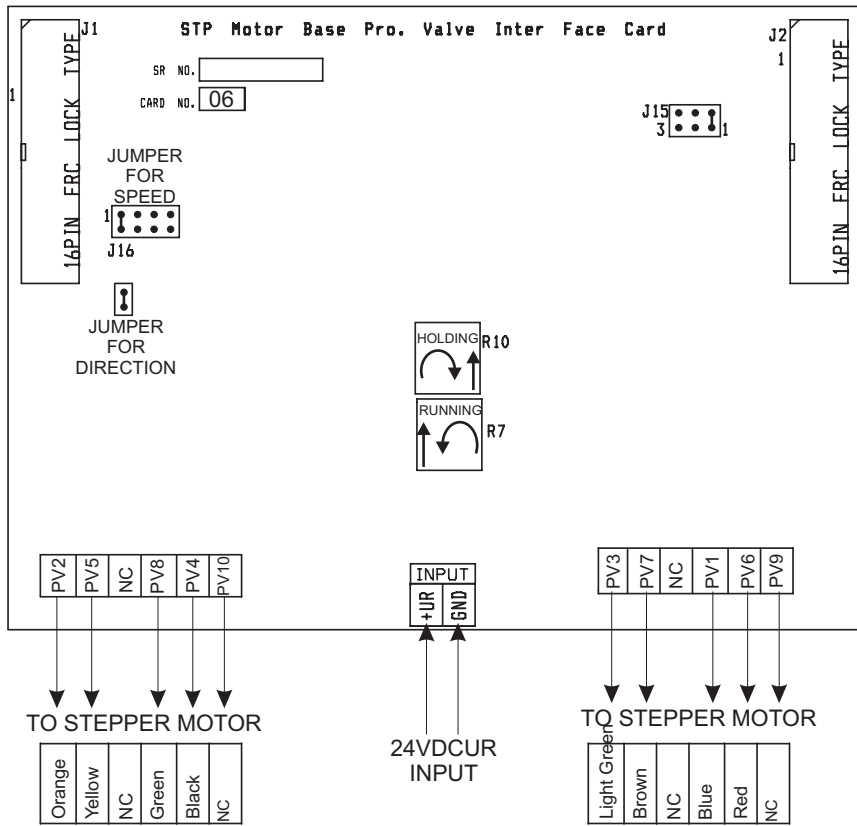

PV 1	Orange
PV 2	Blue
PV 3	Light Green
PV 4	Black
PV 5	Red
PV 6	Yellow
PV 7	Brown
PV 8	Green
PV 9	White
PV 10	White

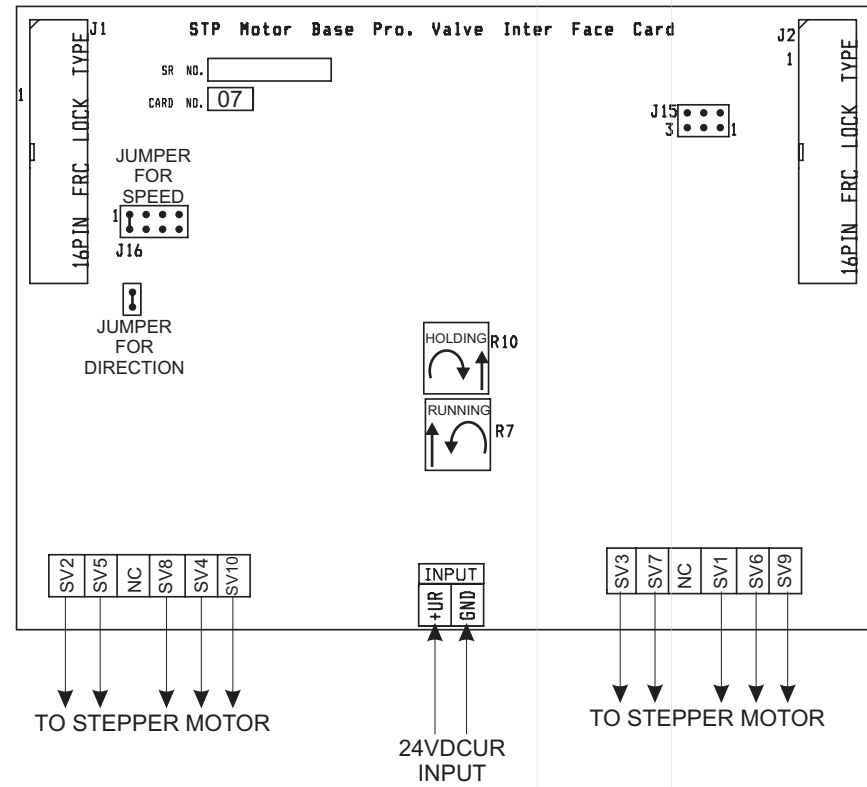

SV 1	Orange
SV 2	Blue
SV 3	Light Green
SV 4	Black
SV 5	Red
SV 6	Yellow
SV 7	Brown
SV 8	Green
SV 9	White
SV 10	White

Module Number	J15 Jumper Pin Setting
Analogue Output Interface with Stepper Module - 6	
Analogue Output Interface with Stepper Module - 7	

Note: All Analogue Output Interface with Stepper modules are the same.

J15 position decides Analogue Output Interface with Stepper module number.

For ex. for **J15=0** (Module No: 0), the corresponding analogue output will be AN1 (Analogue Output 1).

for **J15=1** (Module No: 1), the corresponding analogue output will be AN2 (Analogue Output 2).

For description of AN1.. To ANX, Please refer INPUT/OUTPUT list in the operating manual.

All Analogue output Interface with Stepper modules are same and can be identified by the jumper setting of **J15**.

